



MACHINE PROTECTION DOORS
– NORDIC 344-prottec
– NORDIC 344-rollback

NORDIC
door

NORDIC door was founded 1991 and has a very long experience of high speed roll doors, our doors are developed, designed and manufactured in our factory in Halmstad.

Export is an important part of our business and NORDIC doors are installed in more than 50 countries. The design of the door and the documentation are made to allow the doors to be mounted into production cells without support from NORDIC staff.



A reliable partner

NORDIC door is a leading manufacturer of roll doors with more than 25 years of experience in the door business. Inhouse design and manufacturing of the doors certifies that the doors meet demanding function- and quality standards. Thank's to the inhouse production there is close control of the whole manufacturing chain and all spare are parts available for rapid delivery.



Drive unit- fast and reliable

The drive unit- NORDIC DRIVE A-2 has a robust worm gear with a 1.1 kW AC- motor controlled by a PLC and an advanced Vector- inverter. The drive unit is designed to operate the door up to six times per minute at a speed of up to 2.5m/s.

Side guides - compact, robust and space saving

The compact side guides (only 80mm wide!) are made from heavy gauge anodized aluminium profiles and can easily be dismantled for service, etc.

Door panel- with advanced safety

The NORDIC 344 door panel is 2mm thick and extremely resistant to wear and even weld sparks. It has a patented fold to keep the door panel within the frames, an important safety detail.

The door is tested according to EN ISO 14120-2015. When testing with a pendulum (141 J), the door panel is pushed back only 160mm with no damage made to the door.

Safety – meeting high standards

At the bottom of the door panel there is a self monitoring electric safety edge with wireless connection.

A touchless safety photocell curtain, monitoring the whole opening is optional. In the side guides there are non-contact switches (PLe) that immediately indicate if the door leaves closed position.

Door control – with flexibility

NORDIC 344 has a flexible PLC-control that can be programmed for various operational states.

Customization

NORDIC door enjoys challenges and are open to adapt the doors and controls to various operational states.

NORDIC 344-protoc and 344-rollback machine protection doors – the most advanced on the market!

NORDIC 344-protoc is developed from a new concept with a patented push-out protection system.

This has made it possible to design a door with side frames only 80 mm wide – maintaining workplace safety.

Safety

- Patented push-out protection, keeping the door panel in the frames if attempts are made to push it out. This allows the door to be installed closer to the work station.
- New improved rounded bottom beam which cannot be tilted, making the non-contact switches (PLe) reacting faster and safer.
- Electrical safety edge with wire-less function or alternatively contactless safety photocell curtain monitoring the whole opening.
- LED stripes in different colours, raising awareness to closing door. The LED can be connected to change between 5 different colours and can therefore also be used to provide information to the operator.

Function

- Alternative drive systems with or without vector-inverter control or direct started drives.
- Flexible motor bracket with 4 alternative motor positions, up/down/front/rear.
- New type of bracket for the non-contact switches, allowing the closed position of the door easily to be reset to any height of the opening.
- Stop position bracket with damping capacity.

Design

- Attractive design, completely in anodized aluminium finish.
- Décor stripes for the frames and the bottom beam.
- Slim frames for minimal space requirements.
- Channels for motor cables integrated in the frames.
- Compact covers for the top roll and drive unit.

Installation

- Prepared for fixing to various fencing systems.
- Rigid and self-supporting door structure, fitting the door direct to a machine or a fence is possible.
- Simplified installation as the top roll assembly with top roll, to brackets and drive unit can be installed as a unit.
- Detailed manuals in several languages. Electrical drawings in E-plan.

Bottom profile with rounded top for improved safety. Inspection window over safety switch.



Contactless safety switch (ABB-Jokab standard, other makes optional). Can easily be adjusted to different positions.



Touchless safety photocell curtain located, well protected, in the frames.



Bottom profile with rounded top. Top- and motor covers in anodized aluminium. Control box type A2-standard.



Patented fold on the door panel prevents it from coming out of the frames.

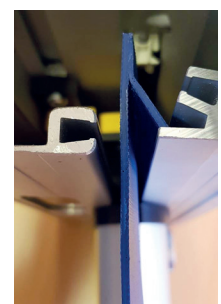

A new generation Vector-control for automatic doors, designed for intensive operation, allowing cycle times down to 10 seconds.

NORDIC DRIVE

Intelligent PLC-control that automatically programs and optimizes the Vector-motor control for different drive conditions, speeds etc. No frustrating stepping through long lists of programs.

As always when looking at NORDIC products, the NORDIC DRIVE has a very robust design with very few wear parts. NORDIC DRIVE A-2 is therefore extremely easy to install, service and maintain. No special program module is needed. Start-up is easily made with the help from the touch display mounted in the front of the control box.

In the control, all status information and history about use, down times etc. is stored. The control can easily be updated with new functions using an optional memory card.



NORDIC DRIVE A2

Adjustable opening speed up to 2,5m/s.

Soft start/ Soft stop. Drive unit type NORDIC DRIVE FL50, 1.1kW.

Encoder integrated in the gearbox.

Standard supply 1x230V 16A, 3x400V optional.

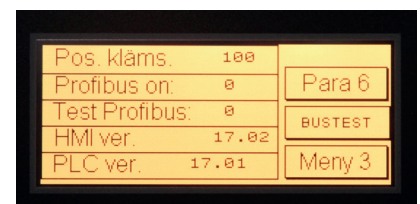

NORDIC DRIVE A2- Profisafe version

The control can optionally communicate with different types of industrial networks type Profisafe, Profibus, Profinet, IO, etc.

Contact NORDIC door

NORDIC door ab – P O Box 4056 – S-300 04 Halmstad, Sweden, Phone: +46 35 10 00 30, info@nordicdoor.se, www.nordicdoor.se



NORDIC 344-protec

Compact, space saving design.
 Top roll front side for simple installation against flush surfaces or against fence posts.
 Easy to serve from outside cell.



NORDIC 344-rollback

Compact, space saving design.
 All moving parts inside the cell for maximum safety.
 Allows forklift trucks to get closer to the door when changing tools in the cell.

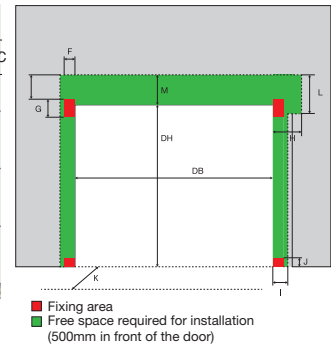
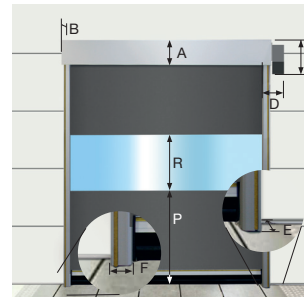
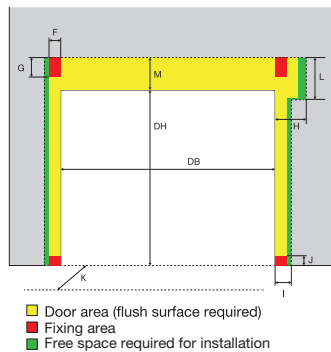
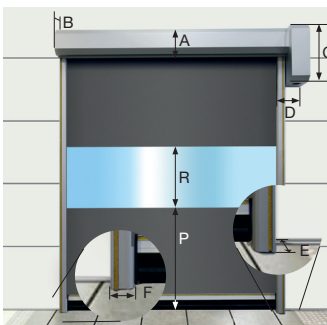
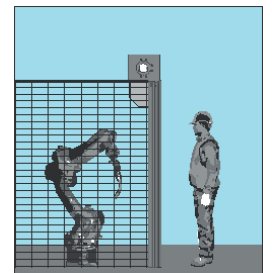
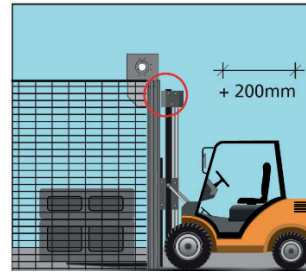
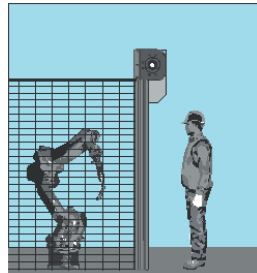
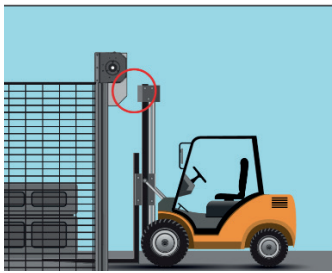

Space requirement, mm: (DB = requested clear width, DH= requested clear height)

A	B	C	D	E	F	G	H	I	J	K	L	M
260	270	640	260	120	80	250	350	150	100	500	650	450

Technical data

Safety edge	Electrical with wireless communication	Standard
Door line photocell	Integrated in the frames	Optional
Safe signal "door closed"	Contactless switches (PLe) mounted in the frame – monitoring closed door	Optional
Inspection window	Inspection window for contactless switches	Optional
Safety photocell curtain	Photocell curtain – touchless monitoring the opening when the door closes (replacing safety edge)	Optional
Attention LED	LED stripes in different colours (red, green, white, yellow, blue) with pre-closing function	Optional
STO (Safe Torque Off)	STO function possible for manual reset or in combination with Profisafe	Optional
Safety scanner	Safety scanner for increased security at high closing speeds etc.	Optional

DRIVE UNIT/ CONTROL

Control system	NORDIC DRIVE A2	Standard
Drive unit	Worm gear drive with electrical motor	Standard
Possible no of cycles	Up to 6 cycles per minute	Standard
Opening speed	Up to 2,5 m/s	Standard
Closing speed	Up to 1,2 m/s	Standard
Closing speed special	Increased closing speeds	Optional
Motor power	1.1kW	Standard
Fusing	16 A (13A)	Standard
Supply voltage	230V, 50Hz-60Hz (optionally 3x400V)	Standard
Supply voltage special	Various supply voltages available	Optional
Control voltage	24 V DC	Standard
Enclosure class	IP54	Standard
Control cabinet size	240x600x240 mm (WxHxD)	Standard
Main switch	Located on left-or right side of the control box	Optional
Motor cables	Power/signal cables between drive and control connected and tested from factory	Standard
Manual opening	Hand crank and crank switch	Optional
Opening upon power failure	UPS battery backup	Optional
Special control systems	NORDIC DRIVE A0 and NORDIC M1 (direct start)	Optional

COMMUNICATION/SIGNALS

Display	HMI text/ touch display for information and programming (several languages)	Standard
Remote control	Prepared to receive commands "up/stop/down"	Standard
General alarm	General alarm (volts free terminals)	Standard
Stop positions	Volts free terminals for information door"open" and "closed"	Standard
Bus-systems	Communication device Profisafe, Profinet, Profibus, etc	Optional
STO (Safe Torque Off)	STO function available	Optional
Attention lights	LED stripes, can be controlled to change between red, green, white, yellow and blue colour	Optional

DOOR PANEL

Material	2-layer mono/multifilament fabric, coated with PVC, 2mm (2400 g/sqm), resistant to weld sparks	Standard
Electrostatic properties	Antistatic (prEN 1718) with integrated carbon fibres	Standard
Door panel colours	Blue(RAL 5007), Grey(RAL7038) Yellow(RAL 1023), Orange(RAL 2004), Red(RAL3000)	Standard Optional
Vision panel in the door panel	Transparent or bronze (eye protective), sizes on demand	Optional

MATERIALS

Frame prof. and bottom beam profile	Anodized, extruded aluminium	Standard
Top tube	Anodized, extruded aluminium	Standard
Top roll cover/motor cover box	Anodized sheet aluminium	Standard

SIZES

Clear width (min/max)	600/4000mm
Clear height (min/max)	600/4000mm
Special sizes on demand	

NOTE

Tested according to EN ISO 14120-2015
Conforms with Directive E305/2011 and Directive 2006/42/EG

Contact NORDIC door

NORDIC door ab – P O Box 4056 – S-300 04 Halmstad, Sweden, Phone: +46 35 10 00 30, info@nordicdoor.se, www.nordicdoor.se



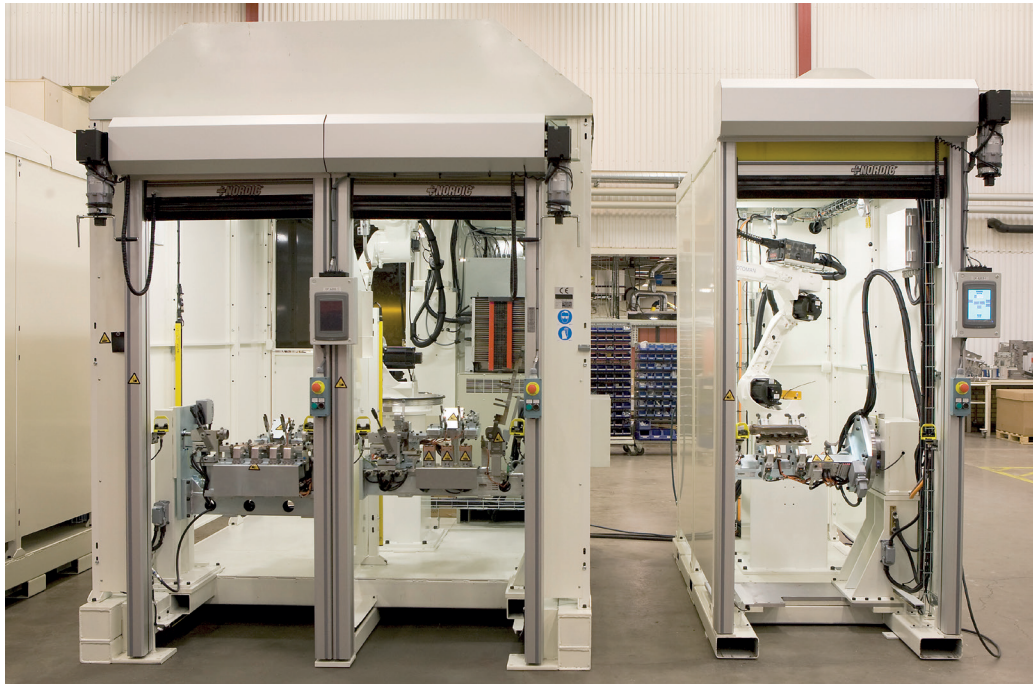

Safety • Quality • Environment

Efficient Machineprotection doors

Improves labour safety and working environment.
Touch less opening/closing for fast and safe passages.



NORDIC IS A REGISTERED TRADEMARK
www.nordicdoor.se